

Fundamental study on the impacts of water-cooling and accumulated dust on photovoltaic module performance

Fawaz Ahmed Ali Alwesabi¹, Ali Saleh Aziz², Mohamad Shukor Abdul Rahim¹,
Mohammad Faridun Naim Tajuddin¹, Mohd Fayzul Mohammed¹, Azralmukmin Azmi¹,
Chris Satterlee³, Shahrin Md Ayob⁴, Tole Sutikno⁵

¹Faculty of Electrical Engineering Technology, Universiti Malaysia Perlis, Perlis, Malaysia

²Department of Electrical Power Techniques Engineering, Al-Hussain University College, Karbala, Iraq

³Independent Researcher

⁴School of Electrical Engineering, Faculty of Engineering, Universiti Teknologi Malaysia, Johor, Malaysia

⁵Department of Electrical Engineering, Faculty of Industrial Technology, Universitas Ahmad Dahlan, Yogyakarta, Indonesia

Article Info

Article history:

Received Apr 16, 2022

Revised Aug 5, 2022

Accepted Aug 26, 2022

Keywords:

Dust

Efficiency

Outdoor testing

Photovoltaic

Water-cooling

ABSTRACT

Photovoltaic (PV) modules have been becoming well-spread recently as alternative clean energy sources to traditional energy sources due to their efficiency and sustainability benefits. This paper applied various water temperatures and artificial dust levels to a couple of monocrystalline PV modules under outdoor conditions to observe their performance. Two different IV tracers were connected separately to each module for comparison purposes. Two temperature sensors were installed at the back of the panels to observe the cell temperatures. Besides, a temperature sensor was specified for ambient readings. Water flowed through an adjustable water-flow sensor to cool the overheated PV module using specific mass flow rates. The results indicate that the efficiency of the PV module starts to reduce when the panel temperature begins to surpass 49.1°C. It was discovered that cooling the PV module increases its efficiency from 0.97 percent at the lowest rate to 4.70 percent at the highest rate. Furthermore, accumulated dust on the PV module top surface can be reduced up to 3-fold under 110 g/m² of dust, and up to 29.30% under 10 g/m² of 100% of its generated energy. Improvement techniques and future work on PV module performance are also discussed.

This is an open access article under the [CC BY-SA](https://creativecommons.org/licenses/by-sa/4.0/) license.



Corresponding Author:

Mohammad Faridun Naim Tajuddin

Faculty of Electrical Engineering Technology, Universiti Malaysia Perlis

Kampus Pauh Putra 02600 Arau, Perlis, Malaysia

Email: faridun@unimap.edu.my

1. INTRODUCTION

In recent years, there have been significant advances in the technologies used to turn solar energy into a sustainable energy supply [1]–[4]. One of the main problems in using photovoltaic (PV) systems is the low energy conversion efficiency of the PV cells. As the panel's operating temperature increases, the open-circuit voltage of the PV cells drops; therefore, the power generated and its efficiency will decrease significantly [5]. The water-cooling method is one of the most helpful techniques that is used to dissipate the heat deposited into the PV modules [6]–[12]. Cooling devices were applied to the PV module to reduce its temperature. The module met elevated solar irradiation and ambient temperature, confirming that dropped PV panel temperature can produce better output energy [13]–[17]. To overcome the overheating problem, it is essential to decrease the temperature of the PV module. PV cells are to be cooled down by supplying water flowing on top of the panel. Water is characterized by its ability to absorb the heat produced by the solar panel cells throughout the

day. The reflective index for air, water, and glass is 1.0, 1.3, and 1.5, respectively. The water refractive index will enhance the visual diffusion of PV cells. Using water to cool the PV module, as shown in the equation below [18], makes a big difference in how much the temperature drops.

The PV output power in the bar graph shown in Figure 1 was produced several times with and without the water-cooling process. The figure demonstrates that PV modules without the cooling process generated the smallest amount of power compared to PV modules with water cooling. A PV module with no cooling process generated 87.1 W of output power. In contrast, a PV module with a water-cooling process and a water temperature of 20 °C produced the highest output power value of 97.6 W. In contrast, the PV module cooled with a water temperature of 45 °C generated the smallest output power value, which is 89 W. The PV module can generate more whenever the temperature of the water-cooling drops. Meanwhile, the lower the water-cooling temperature, the more the heat is dissipated away from the PV module. When the PV module was subjected to water-cooling temperatures of 20 °C and 45 °C, the output power increased by 12.06% and 2.18%, respectively, when compared to the PV output power without the cooling process [19].

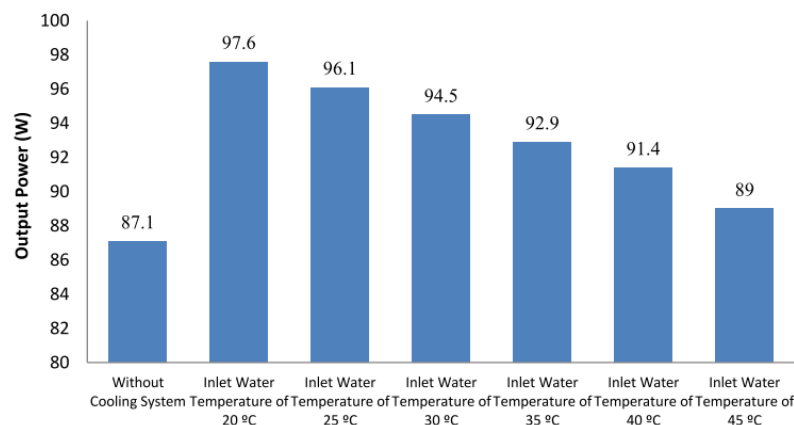

Figure 1. Output power of PV module with different types of cooling method [8]

An experiment in [9] proved that a PV/T water collector's performance, impacted by the change in mass flow rate, is decreased, and the thermal efficiency is increased when the PV temperature is increased. The mass flow rate of the coolant was below 0.10 kg/s. As a contrast, the opposite trend was displayed at more than 0.15 kg/s mass flow rate. Research shows that the PV module temperature can be reduced to 22.4 °C with the aid of 80 L/h of cooling water procedure and constant irradiation of 1000 W/m². It increased the output power and efficiency by 8.04 W and 1.23%, respectively. Temperature, humidity, and dust negatively influence the PV module efficiency, while water cooling procedures can reduce their effect and improve efficiency over time [20]. The top layer of a PV module was tapped with torrential cold water, which reduced the temperature of the PV panel. The cooling system succeeded in reducing the module temperature to approximately 25 °C, while the uncooled module temperature hit 45 °C. The best achievement of this method led to a 20% improvement in power due to no water leakage and an uninterrupted cooling process of the surface. Also, the cooling process caused the power to rise by 20.2 W/m² [21].

Another factor that is thought to impact panel efficiency is dust accumulation on the panel. Dust is often used to describe tiny solid objects with diameters less than 500 nm. It is made up of tiny contaminants that come from a variety of sources, including wind-lifted soil emissions and garbage. While it may appear small, the degradation of our country's air quality will be given careful attention. Globally, high population density, increased industry, and economic expansion have all contributed to a dramatic reduction in urban air quality. When 0.012 g/cm² was placed on the top surface of the solar panel, its output power was dropped to 7.70 W and its efficiency increased to 1.47 percent [22].

PV modules generally show efficiency under standard conditions. Under a variety of continually evolving circumstances, the module performance under outdoor operating conditions is different from that expected from outcomes under standard test conditions. The temperature variations in the solar cells differ. The temperature change will affect the power output of the cells. The output voltage is extremely dependent on the temperature, and a decrease in the voltage accompanies any increment in temperature. Specifically, parameters such as irradiation intensity, mass flow rate of cooling water, and dust can greatly change the efficiency of PV modules. Thus, this paper focuses on designing an examinable prototype of a PV system that

will allow us to compare the output performance of numerous temperature conditions under water cooling applications and compare the performance under several amounts of accumulated dust on the top of PV modules. This current study was conducted at Perlis state, northern of Malaysia.

2. METHODOLOGY

The experiments were conducted outdoors at a maximum ambient temperature of 41.6 °C and a minimum temperature of 27.1 °C. The setup consists of two monocrystalline PV modules connected to water flow and cell temperature sensors with Arduino2 and Arduino1. MPP-IV Swinger 2-tracers were connected between the PV modules and the data logger through Arduinos to indicate the maximum output power produced by the PV panels. Moreover, an independent solar power meter was used for solar radiation readings, and an Arduino-based humidity sensor was used for humidity measuring. Figure 2 illustrates the components of the experiments, which ended with the PC as a data logger.

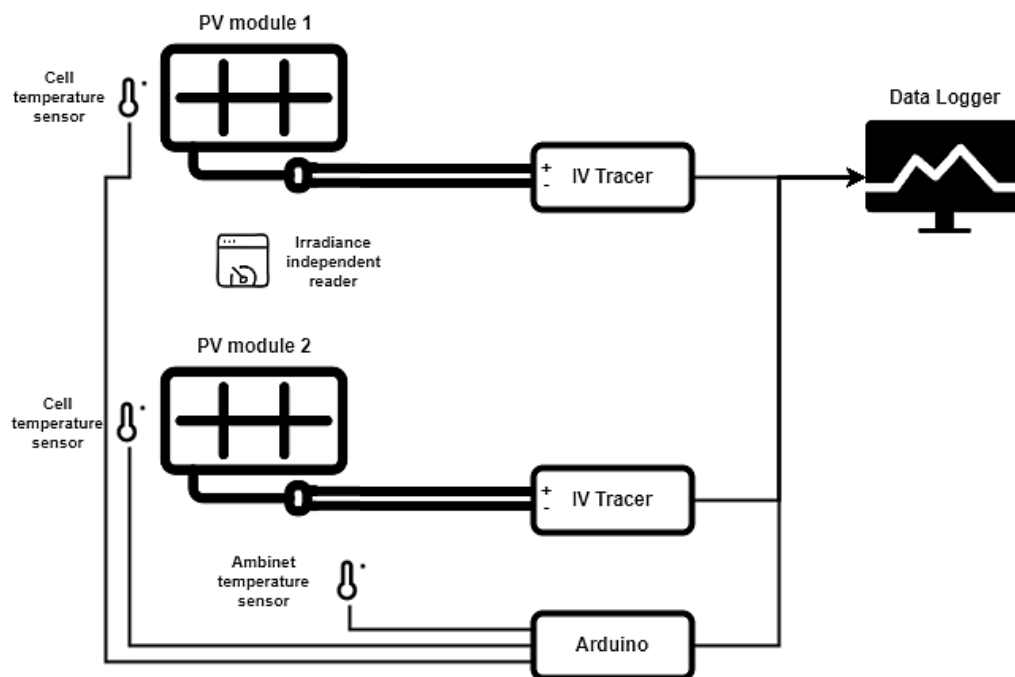

Figure Error! No text of specified style in document.2. Experiment schematic diagram

Figure 3 depicts the construction of the PV prototype in various conditions. The data was collected under three different circumstances. Arduino software was used to evaluate the data obtained on the PC. The various parameters important to the investigation were measured using a variety of instruments, including temperature sensors, two monocrystalline PV modules (GSMG-050M model), three Arduino-based (DS18B20) temperature environment sensors, two I-V tracers, a water flow sensor (YF-B1 model), a common flour to represent dust, and a data taker. Figure 4 depicts a few of the instruments utilized in the experiment, whereas Figures 4(a)-4(d) depict a few of the study's tools and apparatus.

Because natural dust was in scarce supply during the time when the experiment was being carried out in Perlis, Malaysia, the simulated dust was used for the research of dust fouling PV modules. In the current investigation, regular flour was selected to stand in for the dust in order to do an effect analysis on it. In order to extract the I-V characteristics of solar panels, a couple of IV Swinger 2 were employed in this study. The capacitive load is charged according to its basic concept. The load is a capacitor and a single relay, and the gadget is Arduino-based. The Arduino manages the relay and measures, logs, and stores the solar panel voltage and current information. The results are then shown on a laptop in real-time. An effective instrument to evaluate solar I-V characteristics and comprehend the foundations of PV systems in terms of cheap cost, mobility, and quicker reactions is the IV Swinger 2, which is shown in Figure 5 [23]– [25].

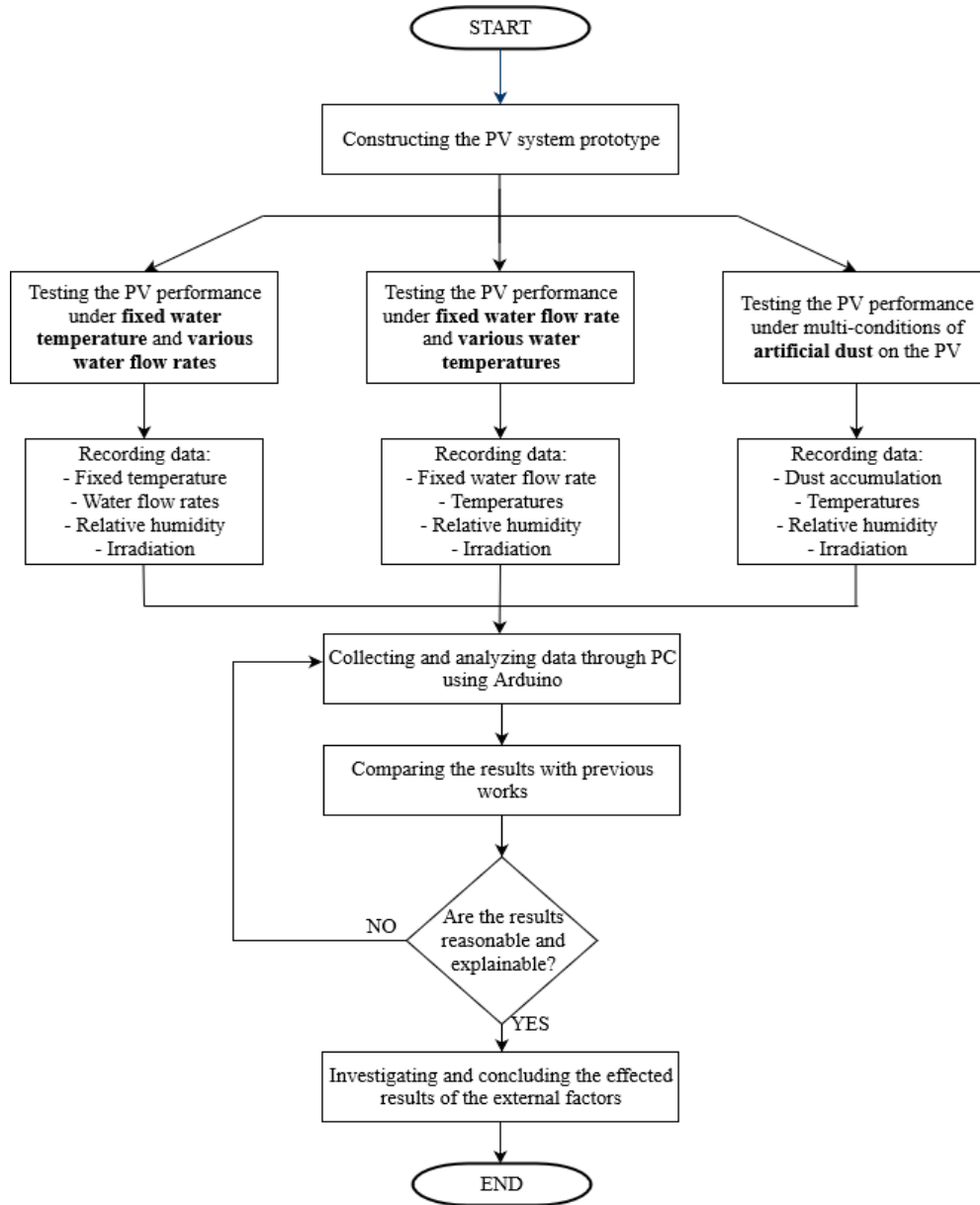

Figure 3. Flowchart outlining the steps of the experiment

The PV module efficiency η , can be calculated using the as in (1).

$$\eta = \frac{P_m}{R_A} \times 100\% \quad (1)$$

Where P_m is the measured output power (W) of the PV taken by the IV tracer, R is the solar irradiation (W/m^2), and A is the PV module surface area, which equals to 660mm long multiplied by 550mm wide, or 0.363 m^2 . The fill factor of the PV module is expressed by the following equation, which might be used to further explore the fill factor (FF) effect.

$$FF = \frac{P_m}{I_{sc}V_{oc}} \quad (2)$$

Where I_{sc} is the short circuit current (A) and V_{oc} is the open-circuit voltage (V) of the module. Accordingly, the PV module efficiency might also be written as in (3).

$$\eta = FF \times I_{sc} V_{oc} \quad (3)$$

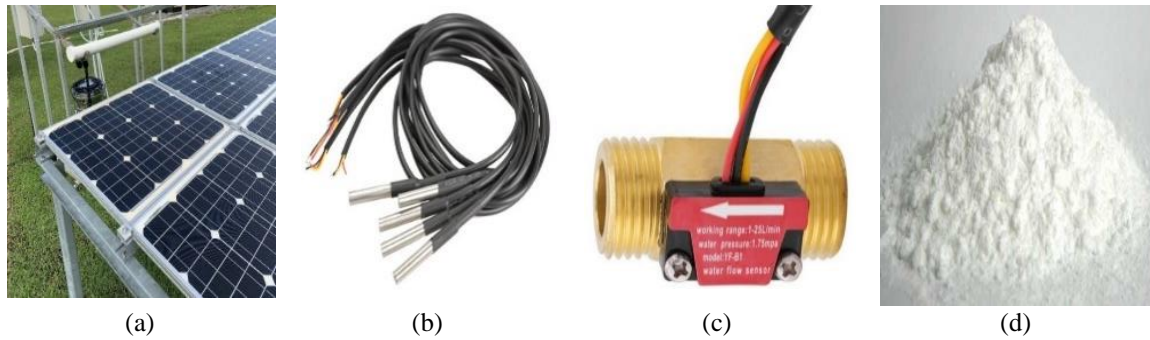

Figure 4. Some of the experiment instruments, (a) monocrystalline PV modules, (b) ambient and cells temperature sensors, (c) water flow sensor, and (d) dust sample

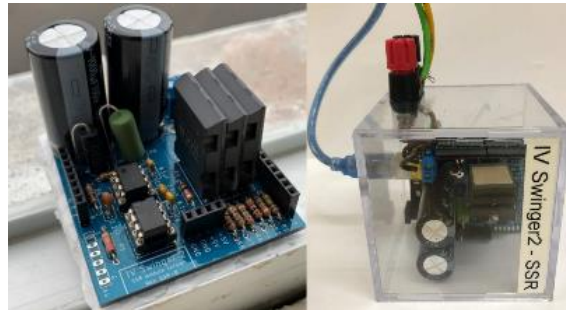

Figure 5. IV Swinger 2 device

3. RESULTS AND DISCUSSION

In 10 separate practical investigations, more than 50 recordings were divided into different circumstances taken by various sensor and reading equipment such as IV Swinger tracers, temperature sensors, radiation reader and water flow sensors. All data was collected at the same time to guarantee that the findings could be compared and analyzed accurately. From 9 a.m. to 5 p.m., random times of the day were selected. The records were selected from the most recent June and July months, taking into consideration the widest possible range of weather circumstances. For the most part, these studies yielded the results shown in Table 1.

Table 1. Summary statistics of collected data

	Ambient Temperature (°C)	Solar Irradiation (W/m ²)	Panel Temperature (°C)	Cooled Panel Temperature (°C)	Voltage (V)	Current (I)	Output Power (W)	PV Module Efficiency (%)
Max.	41.6	895	56.5	45.19	21.2	2.99	46.1	16.30
Min.	27.10	190	33.42	20.87	20.2	0.476	8.83	12.50
Avg.	34.72	598.54	45.70	33.65	20.85	1.8936	31.373	13.82

3.1. Effect of water-cooling technique on energy efficiency of PV module

Two volumes of water-cooling flow rate (0.015 and 0.03) L/s were evaluated with a water spray nozzle to cool down overheated solar cells and decrease the PV module surface temperature for better production of output energy. The cooling technique implicated was a water-type sprayed on the PV surface through an Arduino-based water flow sensor using different water temperatures. Two-panel temperatures were independently installed at the back of two PV modules. The water will stream on the upper side of the panel, encouraging the decrease in cell temperature.

One of the disadvantages of PV technology is that it converts a significant quantity of solar irradiation into heat. Figure 6 describes a permanent increment of solar panel temperature over the surrounding temperature. It is apparent that panel temperatures hit high records when solar irradiation reaches

approximately 630 W/m² and above. Figure 7 shows that the PV panel temperature of the investigated module was cooled significantly more than the reference panel. The highest temperature obtained for the reference panel is 56.5 °C, while with a proper cooling method, the highest temperature can only go up to 45.19 °C. The temperature of the PV panel is directly related to the amount of sunlight that hits it. Figure 8 illustrates the power lines from both systems starting to diverge when the solar irradiation starts to exceed 370W/m². The graph clearly shows that the cooling panel can produce more power than the reference panel. The panel with a cooling system can achieve up to 52 W of output power, while the reference panel power generation can only reach 46.1 W. This means that, with proper cooling, power generation can be improved by up to 11.35%.

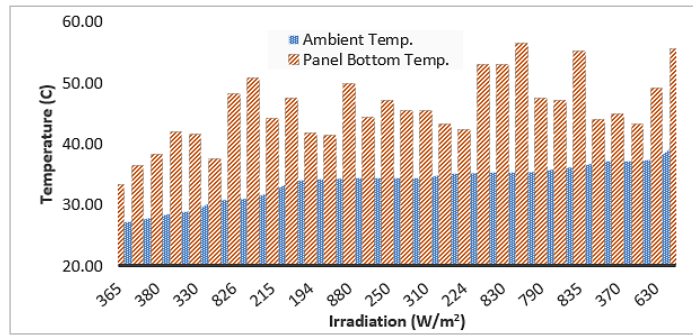

Figure 6. Difference between ambient and PV module temperatures

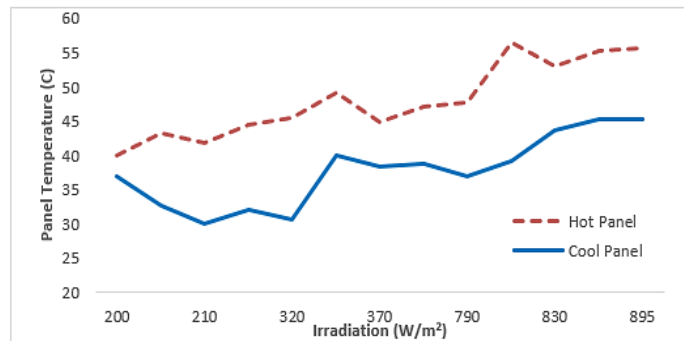

Figure 7. Solar panel temperature with and without cooling

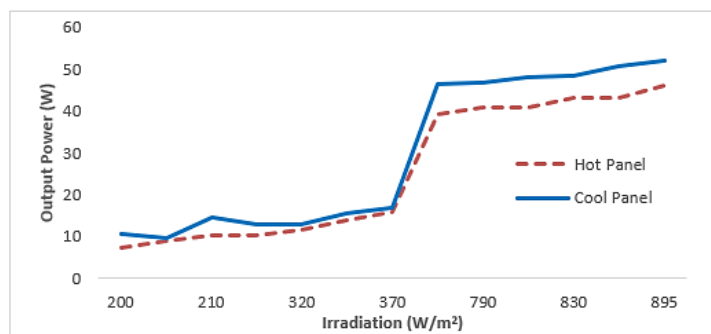

Figure 8. Solar panel output power with and without cooling

Electrical voltage is the physical characteristic that immediately converts into the device's power when measured at the PV modules' maximum power point. During the two stages of the test, the graph in Figure 9 depicts variations in the magnitude of voltage in the examined and reference modules. A greater voltage is

created on the cooled solar generator by lowering the temperature of the modules. The amount of open-circuit voltage that can be boosted is up to 2 V, which can be seen during the highest amount of solar irradiation. The difference in open-circuit voltage between non-cooled and cooled PV is proportional to solar irradiation. The conclusion is that a cooling system is only needed when the amount of radiation is high, not all the time.

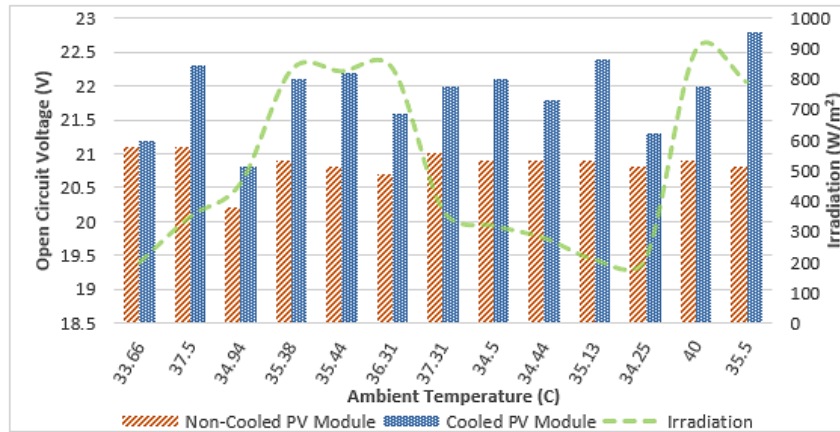

Figure 9. Comparison of cooled and non-cooled PV open circuit voltage with its related irradiation

3.2. Effect of dust on energy efficiency of PV module

The accumulation of dust particles on solar PV systems blocks the sunlight and reduces its power to a large extent. Four sets of dust area density were conducted to examine different obstruction conditions, which were (110, 55, 27, 10) g/m². A perusal of the data recorded indicates the power reduction due to the accumulation of dust on the PV module. The study was implemented using different quantities of artificial dust at irradiation varying from 540 to 890 W/m². Figure 10 illustrates the effect of dust particles on the power output of PV. Analyzing Figure 10, the output power of the PV module was decreased significantly under 110 g/m² of dust. Power drops up to 31.15 W, while the least decrease in output power was recorded under 10 g/m² of dust by 9.2 W. This drop in the output power almost certainly occurred due to the spread of dust on the top glass layer of the PV module.

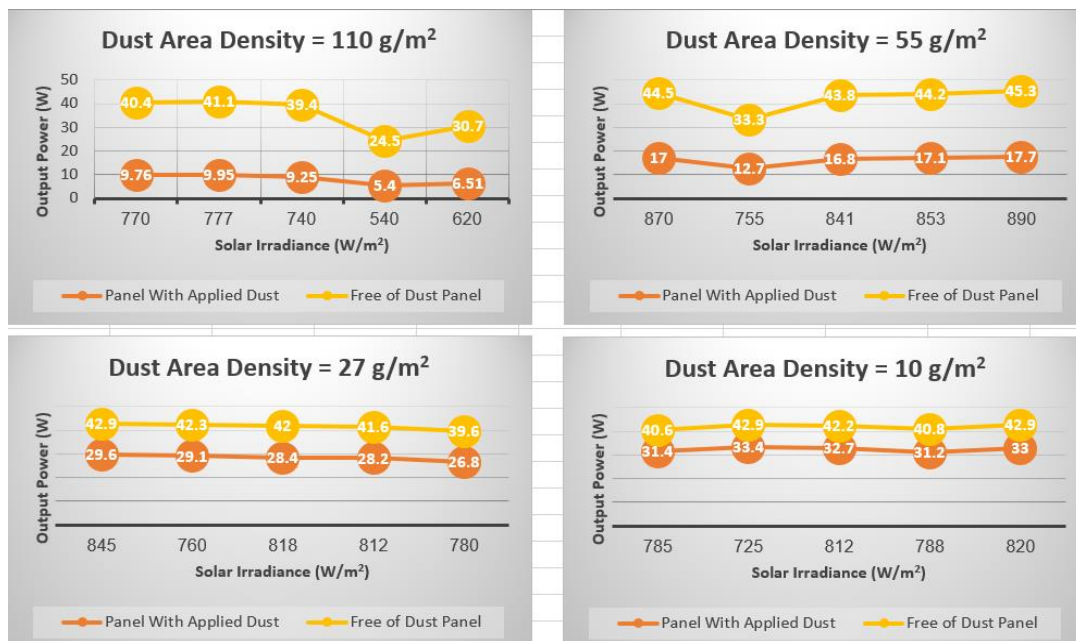

Figure 10. PV performance while applying different amounts of dust

A comparative study between dust-applied and dust-free PV modules is depicted in Figure 11 with respect to their solar irradiation. Accumulated dust particles on PV modules block the sunlight and lower their output power significantly. The dust from different areas, such as constructional locations, agricultural areas, and industrial sites, will badly impact solar system production. The figure below shows the lasting effect of dust on power output throughout all amounts of solar irradiation. The output power of the dust-free PV module is better because it can reach up to 45.3 W, while the output power of the dust-covered PV module is only 16.8 W.

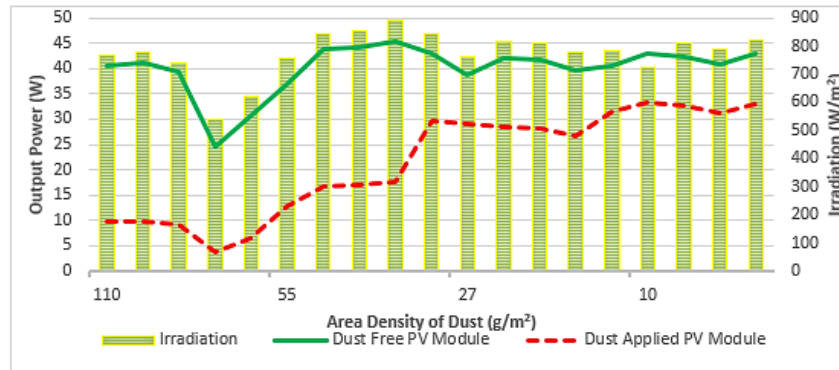

Figure 11. Impact of accumulated dust on PV output power

According to the data in Table 2, the efficiency loss caused by dust on top of PV modules grows exponentially with increasing accumulation. Using (2), the entire PV module efficiency loss is estimated to be 13.77 percent. This indicates that a PV module's produced power can be reduced by up to three times at a dust density of 110 g/m² and by up to 29.30 percent at a dust density of 10 g/m².

Table 2. Efficiency summary of PV module affected by dust

Dust Area Density(g/m ²)	Losses in Efficiency (%)
110	9.74 ~ 11.22
55	7.52 ~ 8.84
27	4.34 ~ 4.78
10	3.22 ~ 3.61

4. CONCLUSION

The influence of water-cooling technology and collected dust on PV performance was investigated by comparing the output performance of two PV modules using two independent IV tracer devices. In this paper, a comparison of output performances under water-cooling applications was studied. Another study of the energy efficiency of the panels was conducted while varied amounts of dust were applied. Furthermore, the temperature of the panels, ambient temperature, and radiation intensity were all monitored at the same time and analyzed to determine their effects. The results showed that the efficiency of the PV module began to decline when the panel temperature exceeded 49.1 °C. Cooling the PV module improved its efficiency by 0.97 percent at the lowest rate and 4.70 percent at the maximum rate. Furthermore, dust deposition on PV modules can lower produced power by up to thrice under 110 g/m² of dust, and up to 29.30 percent under 10 g/m² of dust. Dust, dirt, pollen, bird droppings, and other debris can reduce the efficiency of a PV module. Using cooling methods to keep the PV module temperature within an acceptable range is critical to ensuring that the solar energy harvesting module is capturing and generating optimal electrical power during the day, as operating climatic conditions quickly impact PV module efficiency. To ensure the high potential of power generation from PV systems, an early analysis of irradiation intensity and related obstacles must be applied to the system's site placement. Hundreds of modern readings with more precise technology (if available) might yield more gratifying findings.

ACKNOWLEDGEMENTS



The authors would like to express their gratitude to the Universiti Malaysia Perlis and the Ministry of Education (MOE) of Malaysia for their assistance in providing the necessary resources and funding through the fundamental research grant scheme (FRGS) with the grant number FRGS/1/2020/TK0/UNIMAP/03/30.

REFERENCES



- [1] F. Cucchiella, I. D'Adamo, and M. Gastaldi, "Economic analysis of a photovoltaic system: a resource for residential households," *Energies*, vol. 10, no. 6, pp. 1-15, 2017, doi: 10.3390/en10060814.
- [2] P. Moraitis, B. B. Kausika, N. Nortier, and W. Van Sark, "Urban environment and solar PV performance: The case of the Netherlands," *Energies*, vol. 11, no. 6, pp. 1-14, 2018, doi: 10.3390/en11061333.
- [3] E. Kabir, P. Kumar, S. Kumar, A. A. Adelodun, and K. H. Kim, "Solar energy: Potential and future prospects," *Renewable and Sustainable Energy Reviews*, vol. 82, pp. 894-900, 2018, doi: 10.1016/j.rser.2017.09.094.
- [4] A. Fudholi *et al.*, "Review of solar photovoltaic/thermal (PV/T) air collector," *International Journal of Electrical and Computer Engineering*, vol. 9, no. 1, pp. 126-133, 2019, doi: 10.11591/ijece.v9i1.pp126-133.
- [5] L. Idoko, O. Anaya-Lara, and A. McDonald, "Enhancing PV modules efficiency and power output using multi-concept cooling technique," *Energy Reports*, vol. 4, pp. 357-369, 2018, doi: 10.1016/j.egy.2018.05.004.
- [6] W. Luboń *et al.*, "Assessing the impact of water cooling on PV modules efficiency," *Energies*, vol. 13, no. 10, pp. 1-13, 2020.
- [7] J. Bigorajski and D. Chwieduk, "Analysis of a micro photovoltaic/thermal – PV/T system operation in moderate climate," *Renewable Energy*, vol. 137, pp. 127-136, 2019, doi: 10.1016/j.renene.2018.01.116.
- [8] A. Javed, "The effect of temperatures on the silicon solar cell," *International Journal of Emerging Technologies in Computational and Applied Sciences*, pp. 305-308, 2014.
- [9] I. A. Audwinto, C. S. Leong, K. Sopian, and S. H. Zaidi, "Temperature dependences on various types of Photovoltaic (PV) panel," *IOP Conference Series: Materials Science and Engineering*, vol. 88, no. 1, 2015.
- [10] A. K. Trinh, I. González, L. Fournier, R. Pelletier, J. C. Sandoval V., and F. J. Lesage, "Solar thermal energy conversion to electrical power," *Applied Thermal Engineering*, vol. 70, no. 1, pp. 675-686, 2014, doi: 10.1016/j.applthermaleng.2014.05.088.
- [11] A. Hadipour, M. Rajabi Zargarabadi, and S. Rashidi, "An efficient pulsed- spray water cooling system for photovoltaic panels: Experimental study and cost analysis," *Renewable Energy*, vol. 164, pp. 867-875, 2021, doi: 10.1016/j.renene.2020.09.021.
- [12] P. Dwivedi, K. Sudhakar, A. Soni, E. Solomin, and I. Kirpichnikova, "Advanced cooling techniques of PV modules: A state of art," *Case Studies in Thermal Engineering*, vol. 21, pp. 1-17, 2020, doi: 10.1016/j.csite.2020.100674.
- [13] F. G. Čabo, S. Nižetić, and T. G. Marco, "Photovoltaic panels: A review of the cooling techniques," *Transactions of Famena*, vol. 40, no. SI-1, pp. 63-74, 2016.
- [14] M. R. Gomaa, W. Hammad, M. Al-Dhaifallah, and H. Rezk, "Performance enhancement of grid-tied PV system through proposed design cooling techniques: An experimental study and comparative analysis," *Solar Energy*, vol. 211, pp. 1110-1127, 2020, doi: 10.1016/j.solener.2020.10.062.
- [15] O. M. Al-hababeh, B. A. Al-hrouf, E. A. Al-hiary, and S. A. Al-fraihat, "Durability Prediction of Thin-film PV Modules," *International Journal Engineering Simulation with Industry Applications*, vol. 15, no. 2, pp. 13-21, 2014.
- [16] S. Nižetić, D. Čoko, A. Yadav, and F. Grubišić-Čabo, "Water spray cooling technique applied on a photovoltaic panel: The performance response," *Energy Conversion and Management*, vol. 108, pp. 287-296, 2016, doi: 10.1016/j.enconman.2015.10.079.
- [17] M. Lebbi *et al.*, "Energy performance improvement of a new hybrid PV/T Bi-fluid system using active cooling and self-cleaning: Experimental study," *Applied Thermal Engineering*, vol. 182, 2021, doi: 10.1016/j.applthermaleng.2020.116033.
- [18] M. I. Yusoff, L. W. Zhe, and M. Irwanto, "Comparison of solar panel cooling system by using dc brushless fan and dc water," *Journal of Physics: Conference Series*, 2015, no. 622, doi: 10.1088/1742-6596/622/1/012001.
- [19] M. M. Rahman, M. Hasanuzzaman, and N. A. Rahim, "Effects of operational conditions on the energy efficiency of photovoltaic modules operating in Malaysia," *Journal of Cleaner Production*, vol. 143, pp. 912-924, 2017, doi: 10.1016/j.jclepro.2016.12.029.
- [20] L. W. Zhe *et al.*, "Effect of water cooling temperature on photovoltaic panel performance by using computational fluid dynamics (CFD)," *Journal of Advanced Research in Fluid Mechanics and Thermal Sciences*, vol. 56, no. 1, pp. 133-146, 2019.
- [21] W. Pang, Y. Cui, Q. Zhang, H. Yu, L. Zhang, and H. Yan, "Experimental effect of high mass flow rate and volume cooling on performance of a water-type PV/T collector," *Solar Energy*, vol. 188, pp. 1360-1368, 2019, doi: 10.1016/j.solener.2019.07.024.
- [22] M. M. Rahman, M. Hasanuzzaman, and N. A. Rahim, "Effects of various parameters on PV-module power and efficiency," *Energy Conversion and Management*, vol. 103, pp. 348-358, 2015, doi: 10.1016/j.enconman.2015.06.067.
- [23] W. Lubon *et al.*, "Assessing the impact of water cooling on PV modules efficiency," *Energies*, vol. 13, no. 10, pp. 1-13, 2020, doi: 10.3390/en13102414.
- [24] C. Udagani, "Study of IV characteristics of solar panel using arduino-based IV," *International Journal of Scientific Research and Reviews*, vol. 7, no. 3, pp. 734-740, 2018.
- [25] H. B. Chi, M. F. N. Tajuddin, N. H. Ghazali, A. Azmi and M. U. Maaz, "Internet of things (IoT) based iv curve tracer for photovoltaic monitoring systems," *Indonesian Journal of Electrical Engineering and Computer Science*, vol. 13, no. 3, pp. 1022-1030, 2019, doi: 10.11591/ijeecs.v13.i3.pp1022-1030.

BIOGRAPHIES OF AUTHORS





Fawaz Ahmed Ali Alwesabi    received the B.Eng. degree in electrical engineering from Universiti Malaysia Perlis (UniMAP), Malaysia, in 2020 and currently pursuing his master's degree in project management at Everyone's Smart University. He is now a solar/electrical Engineer at Arabian Power, Jeddah, Saudi Arabia. His research interests include solar photovoltaic systems, particularly in improving the PV module's energy efficiency. He can be contacted at email: alwesabii@gmail.com.





Ali Saleh Aziz    received the B.S. degree in electrical engineering from University of Technology, Iraq, in 2012, the M.S. degree in electrical-power engineering from Universiti Teknologi Malaysia, in 2014 and the Ph.D. degree in electrical systems engineering from Universiti Malaysia Perlis, in 2020. Currently, he is a faculty member at the Department of Electrical Power Techniques Engineering, Al-Hussain University College. He has published refereed manuscripts in various reputable international journals. He is also acting as a reviewer for various reputed journals. His research interests include renewable energy, energy efficiency, and power electronics. He can be contacted at email: iraq_1991@yahoo.com.





Mohamad Shukor Abdul Rahim    received the B.Eng.(hons) degree from the Universiti Malaysia Perlis (UniMAP), in 2014, M.Sc (Electrical System Engineering) degree also from Universiti Malaysia Perlis (UniMAP), in 2016. He is presently pursuing a PhD in Universiti Malaysia Perlis (UniMAP) about photovoltaic PV thermal management, which he started in 2020. His research area of interest is dynamic modeling, photovoltaic cooling, controller optimization. He can be contacted at email: shukorrahim@unimap.edu.my.





Mohammad Faridun Naim Tajuddin    received the B.Eng. and M.Eng. degrees from the University of Malaya (UM), Malaysia, in 2004 and 2007 respectively, and the Ph.D. degree from the Universiti Teknologi Malaysia (UTM), Malaysia, in 2015. He is currently with the Faculty of Electrical Engineering Technology, Universiti Malaysia Perlis (UniMAP). He has published refereed manuscripts in various reputable international journals. His research interests include power electronics control, photovoltaic modeling and control, intelligent control, and optimization techniques. He is also acting as a Reviewer for various reputed journals, such as the IEEE, Applied Energy (Elsevier), Renewable and Sustainable Energy Reviews, Neurocomputing, and Energy Reports. He can be contacted at email: faridun@unimap.edu.my.



Mohd Fayzul Mohammed    received the Bachelor of Engineering in Electrical, Electronics and System degree from National University of Malaysia (UKM) in 2000 and the Master of Engineering in Electrical from University of Malaya in 2006. Currently he pursues his study in Doctor of Engineering in University of Malaya. His current research interests include power electronics topologies, design, and performance evaluation of photovoltaics thermal (PVT), embedded systems and IoT based systems. He is currently working as senior lecturer in Faculty of Electrical Engineering Technology, Universiti Malaysia Perlis (UniMAP). He can be contacted at email: m.fayzul@unimap.edu.my.



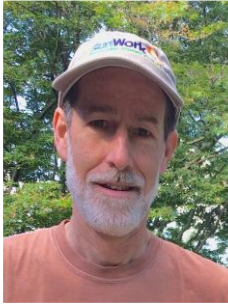

Azralmukmin Azmi    received the B.Eng. degree from the University Malaysia Perlis (UniMAP), in 2007, M.Eng. degree from Universiti Teknologi Malaysia (UTM), in 2009 and Ph.D. degree from UniMAP, in 2022. He is currently with the Faculty of Electrical Engineering Technology, UniMAP. His research interests include artificial intelligence and optimization algorithm in power systems, power electronics and renewable energy. He can be contacted at email: azralmukmin@unimap.edu.my.





Chris Satterlee has a BSEE from Stanford and has worked for multiple Silicon Valley companies doing chip design and verification, system architecture, and software. He is now 'retired until proven otherwise', doing volunteer work in the renewable energy space and creating educational projects like the IV Swinger. He can be contacted at email: csatt1@gmail.com



Shahrin Bin Md Ayob    was born in Kuala Lumpur, Malaysia. He received the degree in electrical engineering, the master's degree in electrical engineering (power), and the Ph.D. degree from Universiti Teknologi Malaysia, in 2001, 2003, and 2009, respectively. He is currently an Associate Professor with the Faculty of Engineering, School of Electrical Engineering, Universiti Teknologi Malaysia. He is also a registered Graduate Engineer under the Board of Engineer Malaysia (BEM). His current research interests include solar photovoltaic systems, electric vehicle technology, fuzzy systems, and evolutionary algorithms for power electronics applications. He can be contacted at email: e-shahrin@utm.my.



Tole Sutikno    is an electrical engineering lecturer at Universitas Ahmad Dahlan (UAD) in Yogyakarta, Indonesia. In 1999, 2004, and 2016, he got his B.Eng., M.Eng., and Ph.D. degrees in Electrical Engineering from Universitas Diponegoro, Universitas Gadjah Mada, and Universiti Teknologi Malaysia, respectively. Since 2008, he has worked as an Associate Professor at UAD in Yogyakarta, Indonesia. He is the current Editor-in-Chief of TELKOMNIKA, as well as the Head of the Embedded Systems and Power Electronics Research Group. Digital design, industrial applications, industrial electronics, industrial informatics, power electronics, motor drives, renewable energy, FPGA applications, embedded systems, artificial intelligence, intelligent control, and digital libraries are among his research interests. He can be contacted at email: tole@ee.uad.ac.id.