

Multilevel Inverter Based Active Power Filter for Harmonic Elimination

G.Nageswara Rao¹, P. Sangameswara Raju², K. Chandra sekhar³

¹Department of Electrical and Electronics Engineering, Vijaya Institute of Technology for Women, India

²Department of Electrical and Electronics Engineering, S.V.University, India

³Department of Electrical and Electronics Engineering, RVR & JC., Acharya Nagarjuna University, India

Article Info

Article history:

Received Jun 12, 2013

Revised Aug 10, 2013

Accepted Aug 26, 2013

Keyword:

ANFIS

Multilevel inverter

NFC

SVM

Switching angle

ABSTRACT

In this paper, support vector machine (SVM) and fuzzy based feedback harmonic elimination technique is proposed. The proposed technique is to overcome the drawbacks of control rule selection of fuzzy logic. Here, the feedback error voltage and change of error voltage of the load is applied as the input of fuzzy logic. The Fuzzy Logic Controller (FLC) builds the logical rules; it depends on the input error voltage and change of error voltage. From the fuzzy rules, the basic SVM takes a set of input data and predicts optimum switching angle and frequency, for each given input. Then, the selected switching angle and frequency is applied to multilevel inverter and the harmonics of the system is eliminated. The proposed method is implemented in MATLAB/simulink working platform and the harmonic elimination performance is demonstrated by the comparison of Neuro Fuzzy Controller (NFC) and Adaptive Neuro Fuzzy Interference System (ANFIS).

*Copyright © 2013 Institute of Advanced Engineering and Science.
All rights reserved.*

Corresponding Author:

G.Nageswara Rao,
Department of Electrical and Electronics Engineering,
Vijaya Institute of Technology for women
Jawaharlal Nehru Technological University, Kakinada
Andrapradesh, India.
Email: gnrudipudi@gmail.com

1. INTRODUCTION

A multilevel inversion known by the power conversion approach diminishes the total harmonic distortion (THD) by getting the output voltage in steps and taking the output nearer to a sine wave [2]. Generating an estimated sinusoidal voltage from multiple stages of dc voltages, usually got from capacitor voltage sources is the general objective of multilevel inverters [1]. Using transformers, a multi-pulse inverter like 6-pulse or 12-pulse inverter accomplishes harmonic with reactive power (VAR) compensation through numerous voltage-source inverters interrelated in a crisscross manner [3]. A few power electronics applications are Flexible ac transmission systems, renewable energy sources, uninterruptible power supplies and active power filters; in which multilevel inverters are significant [4]. For power increase and harmonics reduction of AC waveform, Multi-level inverters (MLI) have materialized as a victorious and practical solution [19]. Non-linear loads like adjustable speed drives; electronically ballasted lighting and the power supplies of the electrical with equipment applied in present offices affect current harmonics in recent electrical allocation systems [5]. By these harmonic currents, Voltage alteration is generated as they unite with the impedance features of the supply systems [6]. Extra heating losses, shorter insulation lifetime, increased temperature and insulation stress, decreased power factor, decreased output, efficiency, ability and deficiency of plant system performance happen thus of a raise in the harmonic alteration component of the transformer [7]. To diminish the problem of harmonics, different methods have been recognized. A few examples are: 1) Specific Harmonic Elimination (SHE) [18] which is applied for abolition of discarded lower

order harmonics and control of fundamental voltage in a square wave. 2) Harmonic elimination pulse width modulation (HEPWM) technique that has a number of advantages compared to traditional sinusoidal PWM (SPWM) for Voltage Source Inverters (VSI) [8]-[9]. Eradication of harmonics in nonlinear system is moreover attained by using a non-natural neural Network [10]. Lately, Shunt Active power filter is commonly utilized for eliminating harmonics and for improving power factor to eradication of the negative and zero series elements [11]. Intended for abolition of harmonics, an Active power filters are widely employed. The shunt compensator APF exterminates commotion in current, whereas the series compensator dynamic voltage Restorer (DVR) destroys turbulence in voltage [12]. By avoiding generation or consumption of reactive power, the load harmonic currents can be effectively reimbursed with fundamental frequency components by planning the active filter controller to take out and insert load harmonic currents and maintain up a steady dc capacitor voltage [13]. Using pulse width modulation or by controlling the dc-link voltage, it has the prospective to change the amplitude of the synthesized ac voltage of the inverters [14]-[15]. Solitary technique applied to recognize active filter current indications is by linking L_f and C_f on the AC and DC sides correspondingly and standards can be met and power rating of the APF can be reduced by employing choosey harmonics compensation [16]-[17]. In the paper, support vector machine (SVM) and fuzzy based feedback harmonic elimination technique will be proposed. The proposed technique is overcome the drawbacks of control rule selection of fuzzy logic. Here, the feedback error voltage and change of error voltage of the load is applied as the input of fuzzy logic. The Fuzzy Logic Controller (FLC) build the logical rules; it is depends on the input error voltage and change of error voltage. From the fuzzy rules, the basic SVM takes a set of input data and predicts optimum switching angle and frequency, for each given input. Then, the selected switching angle and frequency is applied to multilevel inverter and the harmonics of the system is eliminated.

2. MULTILEVEL INVERTER

Maintaining the power quality is one of the important tasks a device which is operating based on power electronics device. Power quality problem occurs due to non linearity loads connected in the system. These non linear loads cause different types of power quality problem in the system such as harmonics sags and etc. To reduce the harmonic contents present in the multilevel inverter output voltage is used to maintain the power quality. Here, the harmonic elimination on the multilevel inverter using SVM and fuzzy based technique has been proposed. The proposed method structure is given in the Figure 1.

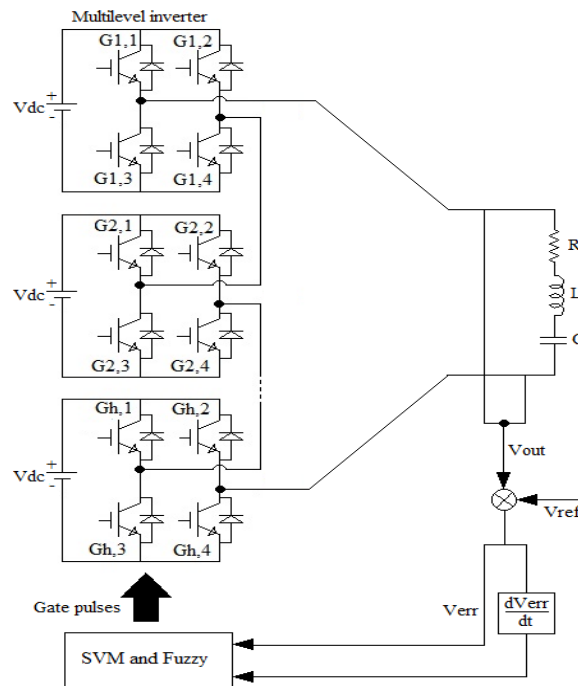

Figure 1. Structure of the Proposed Method

The proposed method is described with the multilevel inverter, i.e, seven level inverter; the output of the multilevel inverter is connected to the nonlinear load. In the multilevel inverter each bridge contains Insulated Gate Bipolar Transistors (IGBT). Each bridge contains its own identical dc supply V_{dc} . The output of the multilevel inverter is given to the nonlinear RLC load. Here, the system output voltage V_{out} is compared to the reference voltage V_{ref} . The difference between output voltage and the reference voltage is known by the error voltage V_{err} . Then the error voltage and change in error voltage is the input of the proposed hybrid technique, which generates the gate pulses to mitigate the harmonics. The output voltage of the present multilevel inverter is of fundamental sinusoidal staircase waveform, which contains seven levels. The multilevel inverter output harmonic voltage can be described in the following Equation (1).

$$V_{out}(\omega t) = \sum_{n=1}^{\infty} V_h \cdot \sin(n \omega t) \quad (1)$$

Where, $\omega = 2\pi f$, f is the frequency in Hz, t is the continuous time signal; $0 \leq t \leq T$, V_h is the amplitude of harmonics. The THD present in the voltage can be identified from the following Equation (2).

$$THD = \frac{\sqrt{\sum_{k=2}^n [V_{out}(k)]^2}}{V_1} \quad (2)$$

Where, $V_{out}(k)$ is the multilevel inverter output voltage of the k^{th} order, the reduced THD has been achieved by the gate pulses generated from the fuzzy logic and SVM based hybrid technique. The detail explanation about the elimination of harmonic content present in the multilevel inverter output voltage.

2.1. Generating Switching Angle and Frequency Fuzzy Rules

Fuzzy logic is the form of probabilistic logic rules, which deals with reasoning that is approximate rather than fixed and exact. Generally, there are three different process for the fuzzy logic i.e., fuzzification, decision making and defuzzification. In fuzzification process, the given input data is converted into fuzzy values. Finally the fuzzy values are converted into the output. The general structure of the fuzzy logic controller is given in the following figure.

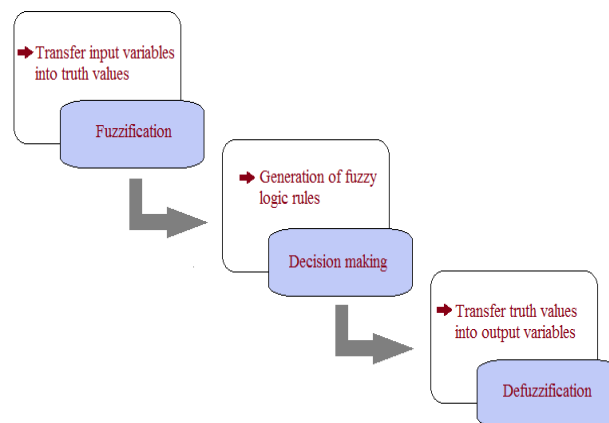

Figure 2. Structure of the Fuzzy Logic Controller

In this method, there are n input variables and $s + 1$ output variables. The input variables are different voltage values, i.e., error voltage and change in error voltage, which are considered for generating fuzzy rules. Here, the error voltage is the difference between the system output voltage $V_{out}(t)$ and reference voltage $V_{ref}(t)$. The input variables are fuzzified into small medium and large. Then the fuzzy rules are generated using the triangular membership function. The fuzzy logic output variables are switching angles

and frequency. The output variables are used to train the SVM, which is briefly described in the following section.

2.2. Multiclass Classifier based Switching Angle and Frequency Prediction

The multiclass classifier is the one of the SVM technique, which classifies the multilevel inverter switching angles and frequency in pair wise. It has two different process likely training and testing. Here the multiclass classifier is trained using the training dataset with above generated fuzzy rules. Then, the testing process of the input is given to the multiclass classifier and obtains the corresponding output. In the proposed method multilevel inverter harmonic elimination, the N training data points (x_i, y_i) are choose, i.e., y_i is the class label and x_i is the input vector, the value of i is in-between the range from 0 to N . The training process of the multiclass classifier requires data set. The experimental steps to predict the switching angle and frequency is given in the following.

Procedure

Step 1: Initialize all the parameters of the multilevel inverter, i.e., the voltage (V), switching angle (θ) and frequency. Here, the voltage (V) and switching angle (θ) are the two classes, which are selected from the separated target class.

Step 2: To identify the decision function of the separated target class, which is given by the following Equation (4).

$$f_{V,\theta}(x) = w_{V,\theta} \cdot K(x, y) + b_{V,\theta} \quad (3)$$

$$w = \sum_{i=1}^N \alpha_i y_i x_i \quad (4)$$

Where, w is the normal to the hyper plane between class m and n , $b_{V,\theta}$ is the offset value of class m and n , $w_{V,\theta} \cdot x$ is the scalar product between $w_{V,\theta}$ and x , $K(x, y)$ is the kernel function and α_i is the non-negative Lagrange multipliers.

Step 3: Apply kernel function; here the $K(x, y)$ value is changed based on the function. The kernel functions are linear, Gaussian, polynomial and tangent hyperbolic. And the resultant function is applied into the Equation (4). The equations for kernel functions are described as follow, Linear kernel function,

$$K(x, y) = (x \cdot y) \quad (5)$$

Gaussian kernel function,

$$K(x, y) = \exp\left(-\frac{\|x - x_i\|^2}{2\sigma^2}\right) \quad (6)$$

Polynomial kernel function,

$$K(x, y) = (x \cdot y)^p \quad (7)$$

Tangent Hyperbolic kernel function,

$$K(x, y) = \tanh(x \cdot y - \theta) \quad (8)$$

Where, σ is the standard deviation and p is the polynomial.

Step 4: To classify the data based on the signum function of the decision function, which is used for setting the threshold decision. The signum function is described as follow:

$$sign (f_{v,\theta} (x)) = \begin{cases} 1 & f_{v,\theta} (x) > 0 \\ -1 & f_{v,\theta} (x) \leq 0 \end{cases} \tag{9}$$

Then, the pair wise function is summed to determine the class decision function. The class decision function of $f_v(x)$ is determined as follow:

$$f_v (x) = \sum_{V \neq \theta; \theta=1}^C sign (f_{v,\theta} (x)) \tag{10}$$

Where, C is the class classification. Similarly, the class decision function of $f_\theta(x)$ is determined. Finally, the $\max_v f_v = (k - 1)$ condition is checked.

Step 5: To evaluate the training and testing error by using the following equation.

$$R_{emp} (\alpha) = \frac{1}{m} \sum_{i=1}^m L (f (x_i, \alpha), y_i) \tag{11}$$

$$R(\alpha) = \int L[f(x, \alpha), y]dP(x, y) \tag{12}$$

Where, Equation (11) is the training error and (12) is the testing error. The process is continued until the training and the testing error gets minimized.

3. RESULTS AND ANALYSIS

The fuzzy and SVM based hybrid technique is implemented in the MATLAB 7.10.0 (2012a). The input dc supply is 230V, the bridge IGBT resistance is 0.1Ω , IGBT diode resistance (R_D) is 0.01Ω , the load $R=10, L=1mH, C=1 \mu H$ respectively and the reference voltage is 230V, 50Hz. The effectiveness of the proposed method is demonstrated with the various techniques like NFC and ANFIS.

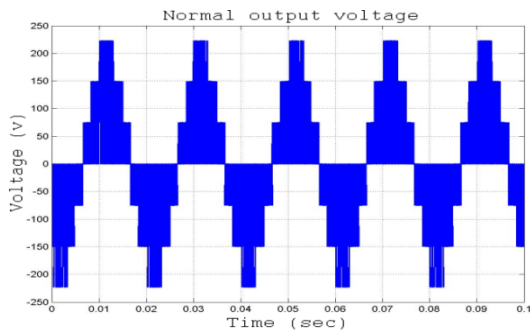

Figure 3. Seven Level Inverter Output Voltage without Controller

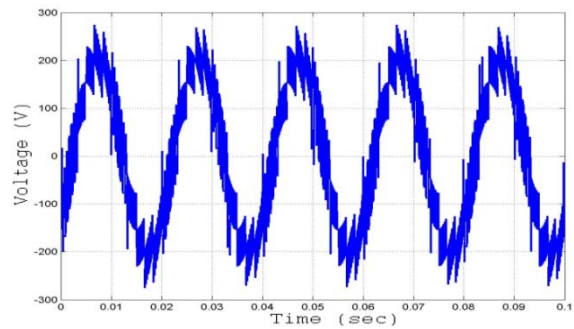

Figure 4. Difference between Normal Output and Reference Voltage

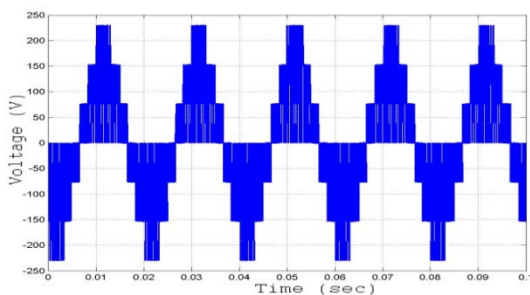

Figure 5. Multilevel Inverter Output Voltage with NFC

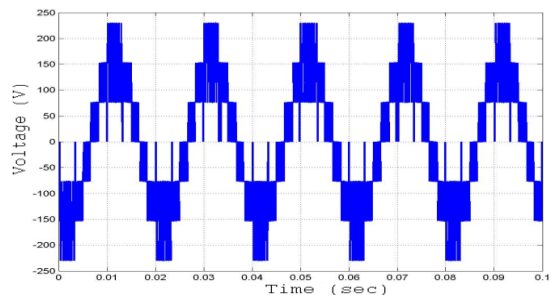

Figure 6. Multilevel Inverter Output Voltage with ANFIS

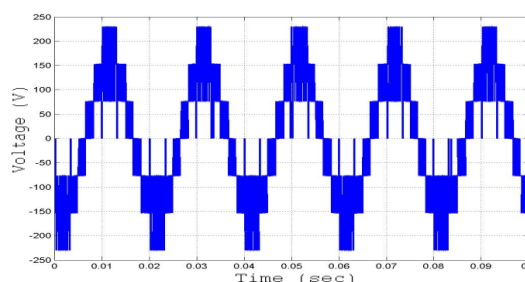

Figure 7. Multilevel Inverter Output Voltage with Proposed Technique

In this section the numerical results of the proposed method are presented and discussed. Comparisons between the proposed system and the NFC, ANFIS are also presented. Here, the maximum time interval used in the proposed technique is $T=0.1\text{sec}$. Initially the multilevel inverter produced the output which is sinusoidal staircase waveform, The output voltage of the multilevel inverter is given to the non linear RLC load ($R=10$, $L=1\text{mH}$, $C=1\ \mu\text{H}$). The presence of the nonlinear load generates the harmonic contents in the output voltage. It is slightly different from the standard waveform and it has distortions. To find the distortion of the output voltage from the comparison of standard voltage and the multilevel inverter output voltage

4. CONCLUSION

The SVM and fuzzy based hybrid feedback controller technique for harmonic content elimination of multilevel inverter was proposed in this paper. Here, the FLC develops the logical rules depending on the error and change of error voltage. From the fuzzy rules the optimum switching angle and frequency were predicted by the SVM technique. By using the selected switching angle the harmonic contents present in the multilevel inverter has been eliminated. Then the proposed method performances are compared to the NFC and ANFIS at various nonlinear load levels. In that the NFC and ANFIS has 12.78% and 10.86% THD respectively but the proposed hybrid technique contains 9.20% THD only.

REFERENCES

- [1] G Murugesan, M Jagabar Sathik, M Praveen. A New Multilevel Inverter Topology Using Less Number of Switches. *International Journal of Engineering Science and Technology*. 2011; 3(2): 1500-1510.
- [2] S Jeevananthan. Evolutionary Computing Based Area Integration PWM Technique for Multilevel Inverters. *Journal of Electrical Systems*. 2007; 3(2): 61-72.
- [3] Eswaran Chandra Sekaran, Ponna Nadar, Anbalagan and Chelliah Palanisamy. Analysis and Simulation of a New Shunt Active Power Filter Using Cascaded Multilevel Inverter. *Journal of Electrical Engineering*. 2007; 58(5): 241–249.
- [4] P Palanivel, Subhransu Sekher, Dash. Phase Shifted Carrier Pulse Width Modulation for Three Phase Multilevel Inverter to Minimize THD and Enhance Output Voltage Performance. *Journal of Electrical Systems*. 2010; 6(2): 1–13.
- [5] A Hussein Attia, M El- Metwally, Osama M Fahmy. Harmonic Distortion Effects and Mitigation in Distribution Systems. *Journal of American Science*. 2010; 6(10): 173-183.
- [6] AF Zobaa. Practical Solutions for Harmonics Problems Produced in the Distribution Networks. *Journal of Electrical Systems*. 2006; 2(1): 13-28.
- [7] I Daut, HS Syafruddin, Rosnazri Ali, M Samila, H Haziiah. The Effects of Harmonic Components on Transformer Losses of Sinusoidal Source Supplying Non-Linear Loads. *American Journal of Applied Sciences*. 2006; 3(12): 2131-2133.
- [8] Vargese Jegathesan, Jovitha Jerome. Non-Traditional Method-Based Solution for Elimination of Lower Order Harmonics in Voltage Source Inverter Feeding an Induction Motor Drive. *Serbian Journal of Electrical Engineering*. 2008; 5(2): 273-283.
- [9] Zainal Salam. An On-Line Harmonic Elimination Pulse Width Modulation Scheme for Voltage Source Inverter. *Journal of Power Electronics*. 2010; 10(1): 43-50.
- [10] O Bouhali, M Berkouk, B Francois, C Saudemont, S Labiod. Solving Harmonics Elimination Problem in Three-Phase Voltage controlled Inverter using Artificial Neural Networks. *Journal of Electrical Systems*. 2005; 1(1): 39–51.
- [11] Moleykutty George, Kartik Prasad Basu. Modeling and Control of Three-Phase Shunt Active Power Filter. *American Journal of Applied Sciences*. 2008; 5(8): 1064-1070.

- [12] Moleykutty George, Kartik Prasad Basu. Three-Phase Shunt Active Power Filter. *American Journal of Applied Sciences*. 2008; 5(8): 909-916.
- [13] Peng Xiao, Ganesh Kumar Venayagamoorthy, Keith A Corzine. Seven-Level Shunt Active Power Filter for High-Power Drive Systems. *IEEE Transactions on Power Electronics*. 2009; 24(1): 6-13.
- [14] Murat Kale, Engin Ozdemir. Harmonic and reactive power compensation with shunt active power filter under non-ideal mains voltage. *Electric Power Systems Research*. 2005; 74: 363-370.
- [15] Sangsun Kim, Prasad N Enjeti. A New Hybrid Active Power Filter (APF) Topology. *IEEE Transactions on Power*. 2002; 17(1): 48-54.
- [16] B Mazari F Mekri. Fuzzy Hysteresis Control and Parameter Optimization of a Shunt Active Power Filter. *Journal of Information Science and Engineering*. 2005; 21: 1139-1156.
- [17] Micah E Ortuzar Rodrigo E Carmi, Juan W Dixon, Luis Moran. Voltage Source Active Power Filter Based on Multilevel Converter and Ultra capacitor DC Link. *IEEE Transactions on Industrial Electronics*. 2006; 53(2): 477-485.
- [18] G Bhuvaneswari, Manjula G Nair. Three-Phase Hybrid Shunt Filters for Power Quality Improvement. *Journal of Power Electronics*. 2007; 7(3): 257-264.
- [19] R Seyezhai, BL Mathur. Performance Evaluation of Inverted Sine PWM Technique for an Asymmetric Cascaded Multilevel Inverter. *Journal of Theoretical and Applied Information Technology*. 2009; 9(2): 91-98.
- [20] Z Salam, J Aziz, SS Ahmed. Digital Implementation of a New PWM Switching Scheme for Modular Structured Multilevel Voltage Source Inverter. *Journal of Energy & Environment*. 2006; 5: 57-76.
- [21] Rup Narayan Raya, Debashis Chatterjee, Swapan Kumar Goswami. A PSO based optimal switching technique for voltage harmonic reduction of multilevel inverter. *Expert Systems with Application*. 2010; 37(12): 7796-7801.
- [22] G Mahesh, Manivanna Kumar, S Rama Reddy. Simulation and Experimental Results of 7-Level Inverter System. *Research Journal of Applied Sciences, Engineering and Technology*. 2011; 39(2): 88-95.
- [23] A Chitra, T Meenakshi, J Asha. Fuzzy Logic Controller for Cascaded H-Bridge Multilevel Inverter. *International Journal of Engineering Science and Technology*. 2011; 3(2).
- [24] T Manokaran, B Sakthivel, S Mohamed Yousuf. Cascaded Multilevel Inverter Based Harmonic Reduction in STATCOM. *International Journal of Engineering Science and Technology*. 2010; 2(10): 5424-5431.
- [25] Jagdish Kumar, Biswarup Das, Pramod Agarwal. Harmonic Reduction Technique for a Cascade Multilevel Inverter. *International Journal of Recent Trends in Engineering*. 2009; 1(3): 181-185.
- [26] G Durgasukumar, MK Pathak. Comparison of adaptive Neuro-Fuzzy-based space-vector modulation for two-level inverter. *International Journal of Electrical Power & Energy Systems*. 2012; 38(1): 9-19.
- [27] Anup Kumar Panda, Yellasiri Suresh. Research on cascade multilevel inverter with single DC source by using three-phase transformers. *International Journal of Electrical Power & Energy Systems*. 2012; 40(1): 9-20.
- [28] Xiaoxia Yin, Brian WH Ng, Bernd M Fischer, Bradley Ferguson, Derek Abbott. Support Vector Machine Applications in Terahertz Pulsed Signals Feature Sets. *IEEE Sensors Journal*. 2007; 7(12): 1597-1608.

BIOGRAPHIES OF AUTHORS



G.N.Rao was born in Guntur, India, in 1975. He received the AMIE (Electrical) degree from the Institute of Engineers (India) and the M.Tech degree from Nagarguna University, Nambur, AP, India. and currently pursuing his Ph.d from J.N.T.University Kakinada .Working as Associate .Prof & H.O.D in Electrical and Electronics Engineering dept,VIJAYA INSTITUTE OF TECHNOLOGY FOR WOMEN ,Vijayawada. His areas of interest are in power systems, electrical machines, electromagnetic fields. Mr.Rao is a Life Member of the Indian Society for Technical Education (ISTE) and Associate Member of the Institution of Engineers (India) [IE(I)].



Dr. K.Chandra Sekhar received his B.Tech degree in Electrical & Electronics Engineering from V.R.Siddartha Engineering College, Vijayawada, India in 1991 and M.Tech with Electrical Machines & Industrial Drives from Regional Engineering College, Warangal, India in 1994, He Received the Ph.D, degree from J.N.T.U College of Engineering, Hyderabad-500072, India. From 1994 to 1995, he was the Design & Testing Engineer in Maitreya Electricals (P) Ltd, Vijayawada. From 1995 to 2000,he worked with Koneru Lakshmaiah College of Engineering as a Lecturer ,since 2000,he has been with R.V.R & J.C.College of Engineering as Prof & H.O.D electrical and electronics engineering. Mail



Dr.P.Sangameswararaju did his Ph.D from S.V.University. Presently he is working as Professor and HOD in the Department of Electrical Engineering, S.V.University, Tirupathi, Andhra Pradesh. He has about 60 publications in National and International Journals and Conferences to his credit. His areas of interest are in Distribution systems and power systems.