

Effect of Parametric Variations and Voltage Unbalance on Adaptive Speed Estimation Schemes for Speed Sensorless Induction Motor Drives

Mohan Krishna. S, Febin Daya. J.L

School of Electrical Engineering, VIT University, Chennai, India

Article Info

Article history:

Received Sep 30, 2014

Revised Dec 8, 2014

Accepted Jan 2, 2015

Keyword:

Adaptive control

Adaptive speed observers

Machine model

Model reference

Speed estimation

ABSTRACT

Speed Estimation without speed sensors is a complex phenomenon and is overly dependent on the machine parameters. It is all the more significant during low speed or near zero speed operation. There are several approaches to speed estimation of an induction motor. Eventually, they can be classified into two types, namely, estimation based on the machine model and estimation based on magnetic saliency and air gap space harmonics. This paper analyses the effect of incorrect setting of parameters like the stator resistance, rotor time constant, load torque variations and also Voltage unbalance on various adaptive control based speed estimation techniques fed from the machine model. It also shows how the convergence mechanisms of the adaptation schemes are affected during these conditions. The equivalent models are built and simulated offline using MATLAB/SIMULINK blocksets and the results are analysed.

*Copyright © 2015 Institute of Advanced Engineering and Science.
All rights reserved.*

Corresponding Author:

Mohan Krishna.S,

School of Electrical Engineering (SELECT),

VIT University, Chennai Campus, Chennai - 600 127, India.

Email: smk87.genx@gmail.com

1. INTRODUCTION

The essence of employing encoderless induction motor drives is to eliminate additional space and cost which would otherwise be attributed to the speed encoder. The use of speed encoders also acts contrary to the inherent robustness of the induction motors. Therefore, estimation of speed without speed sensors emerged as an important concept [1]. Great amount of research has been done in this regard and it continues to inspire more, with the onset of artificial intelligence based speed estimation and other emerging technologies. The speed can be estimated either from the magnetic saliencies or by a machine model fed by terminal quantities. Owing to the complexity of speed estimation, the most discussed problems were the estimator's sensitivity to motor parameter changes, low and zero speed operation, speed estimation at field weakening region, stability problems in the regenerative mode etc.

This paper attempts to present a performance analysis of various adaptive control schemes when they are subjected to load perturbations, incorrect parameter settings (Stator resistance and Rotor time constant) and Voltage unbalance. The effect of the same on the convergence of the adaptive mechanism is also presented.

2. MATHEMATICAL MODEL OF THE INDUCTION MOTOR

The dynamic state space model of the induction motor is presented below, which, aids in the formulation of estimation and control algorithms. It also helps in determining the internal behavior of the

system along with the desired input and output. The stator current and the rotor flux are the state variables [2]:

$$p \begin{bmatrix} i_s^e \\ \psi_r^e \end{bmatrix} = \begin{bmatrix} A_{11} & A_{12} \\ A_{21} & A_{22} \end{bmatrix} \begin{bmatrix} i_s^e \\ \psi_r^e \end{bmatrix} + \begin{bmatrix} B_{11} \\ 0 \end{bmatrix} V_s^e \quad (1)$$

$$\dot{x}^e = Ax^e + Bv_s^e \quad (2)$$

$$i_s^e = Cx^e \quad (3)$$

Where,

$$x^e = [i_s^e \ \psi_r^e]^T, i_s^e = [i_{ds}^e \ i_{qs}^e]^T, \psi_r^e = [\psi_{dr}^e \ \psi_{qr}^e]^T \quad (4)$$

The electromechanical torque is given by,

$$T_e = \frac{3}{2} \frac{P}{2} \frac{L_m}{L_r} (i_{qs}^e \psi_{dr}^e - i_{ds}^e \psi_{qr}^e) \quad (5)$$

3. INDUCTION MOTOR FOC AND SPEED ESTIMATION

In the conventional scalar control of Induction motor, since torque and flux linkages are a function of voltage, current or frequency, there is an inherent coupling present due to which the response is sluggish. Therefore, there is a need to decouple the same, by making the torque independent of flux. This is known as vector control or field oriented control of the Induction motor. This is similar to the orthogonal orientation of the flux and torque achieved in a separately excited dc motor [3]. Generally, the stator current is resolved into the torque producing component and flux producing component. The DC machine like performance is only possible if the flux producing component of the current is oriented in the direction of flux and the Torque component of the current is perpendicular to it. The orientation is possible with either the rotor flux (ψ_r), airgap flux (ψ_m) or stator flux (ψ_s). However, rotor flux oriented control gives natural decoupling effect, whereas airgap or stator flux orientation have coupling in the flux control loop. The Figure 1. Shows the different types of Field Oriented control.

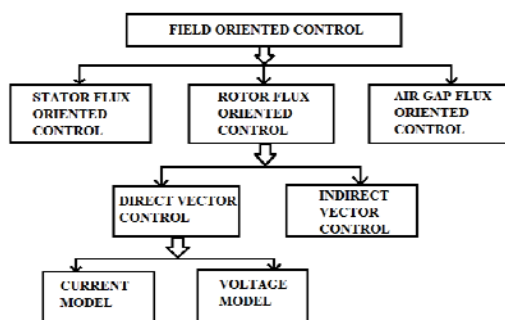

Figure 1. Field Oriented Control schemes for Induction Motor

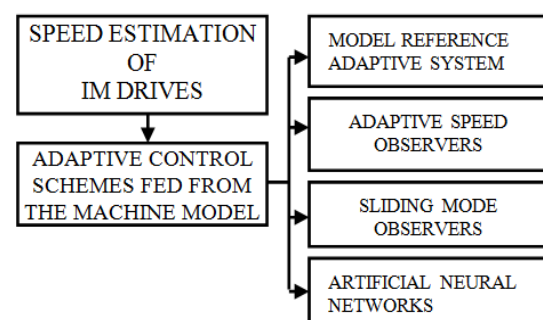

Figure 2. Classification of Speed estimation methods

Figure 2 illustrates the different types of adaptive control schemes fed from the terminal quantities of the machine. These methods display good performance at high and medium speeds. But they are not stable at very low operating speeds as they are parameter dependent and parameter errors can degrade speed performance. The prominent configurations of adaptive speed estimation schemes are presented below.

3.1. Model Reference Adaptive Control (MRAC)

As the name suggests, an adaptive system adapts itself to the controlled system with parameters which need to be estimated or are uncertain. Unlike robust control, it does not need any first hand information about the bounds on these estimated or uncertain parameters. The primary aim of adaptive

control is parameter estimation. The MRAS forms the crux of adaptive control. The MRAS is easy to implement and has a high speed of convergence and adaptation and it also displays robust performance to parameter variations. The general configuration of MRAS is shown in Figure 3. The error vector is obtained as the difference in the outputs of the reference and adjustable models. The two models are fed from the machine terminals. The adaptive mechanism forces the error vector to zero in order to converge the estimated output to the reference output [4]. During the design of the adaptive control scheme, special emphasis has to be laid on the convergence mechanism. Since stability of the estimator is of great concern at all speeds, Lyapunov stability criterion plays an important role in deriving the control laws and force convergence as well as ensure fast error dynamics. Adaptive mechanisms can be in the form of fixed gain PI Regulators, Fuzzy Logic (FL), Sliding Mode (SM) based etc. As Sensorless Model based speed estimation methods are sensitive to machine parameters, several methods and algorithms have been proposed for parameter adaptation also [5], in order to optimise the performance of the drive etc. MRAS based approach varies with the quantity that is selected as output of the reference and adjustable model [6]. The more popular choices happen to be rotor flux, back emf, stator currents and Instantaneous reactive power [7].

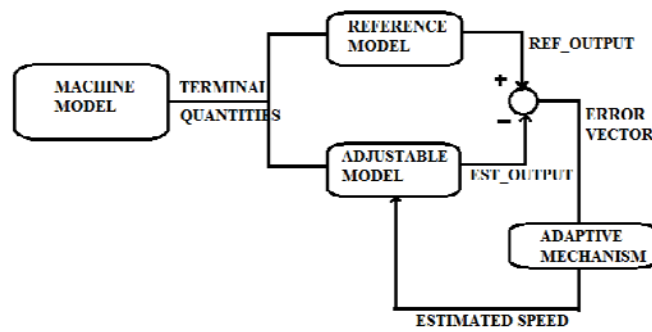

Figure 3. General Configuration of MRAS

The following Equation (6) – (10) are used to characterize the rotor flux based MRAS speed estimator along with the adaptive mechanism used [8]:

a) Reference Model:

$$\psi_{qr}^s = L_r/L_m \int [V_{qs}^s - R_s i_{qs}^s - \sigma L_s i_{qs}^s] dt \quad (6)$$

$$\psi_{dr}^s = L_r/L_m \int [V_{ds}^s - R_s i_{ds}^s - \sigma L_s i_{ds}^s] dt \quad (7)$$

Where $\sigma = 1 - L_m^2/L_s L_r$

b) Adjustable Model:

$$d\psi_{qr}^s/dt = -1/T_r \psi_{qr}^s + \omega_r \psi_{dr}^s + L_m/T_r i_{qs}^s \quad (8)$$

$$d\psi_{dr}^s/dt = -1/T_r \psi_{dr}^s - \omega_r \psi_{qr}^s + L_m/T_r i_{ds}^s \quad (9)$$

c) Adaptive Mechanism:

$$\hat{\omega}_r = \left\{ K_p + \frac{K_i}{p} \right\} (\varphi_q \hat{\varphi}_d - \varphi_d \hat{\varphi}_q) \quad (10)$$

3.2. Adaptive Speed Observers

H.Kubota et al, [9] proposed a Full order speed Adaptive Flux Observer (AFFO) based on adaptive control theory. The AFFO stabilises the performance of the drive even at low speed region by allocating poles arbitrarily. It makes use of either the Lyapunov's stability criterions or the Popov's criterions to derive the adaptive scheme. The AFFO, apart from estimating the Stator current and rotor flux, also makes use of a gain matrix which is used for stability purpose. The general configuration of the observer is shown in Figure 4.

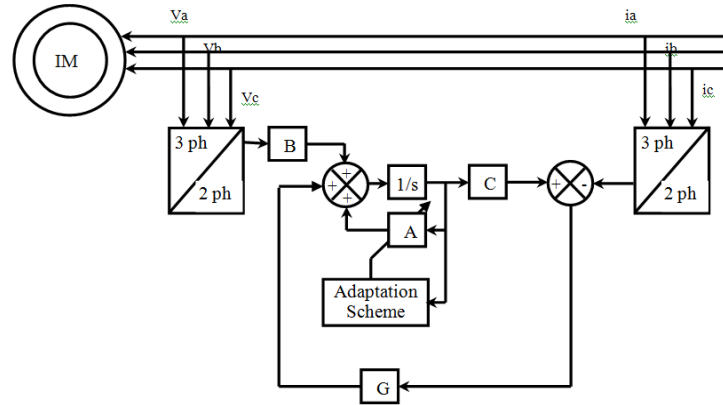

Figure 4. Adaptive Observer scheme for speed estimation

Where, 'A' is the system matrix, the symbol '^' indicates estimated values, 'X' comprises the state variables which are the direct and quadrature axes stator currents and rotor fluxes, 'G' is the observer gain matrix, chosen in such a way that the Eigen values of the observer are proportional to the Eigen values of the machine to ensure stability under normal operating condition. The state equations depicting the structure of the Adaptive Pseudo reduced order speed observer (AFFO) is shown [10]:

(a) Reference Model (Motor model):

$$\frac{dx}{dt} = [A]x + [B]u \quad (11)$$

$$y = [C]x \quad (12)$$

Where,

$$x = [i_{ds}, i_{qs}, \varphi_{dr}, \varphi_{qr}]^T, A = \begin{bmatrix} A_{11} & A_{12} \\ A_{21} & A_{22} \end{bmatrix}, I = \begin{bmatrix} 1 & 0 \\ 0 & 1 \end{bmatrix}, J = \begin{bmatrix} 0 & -1 \\ 1 & 0 \end{bmatrix}$$

$$A_{11} = -\left[\frac{R_s}{\sigma L_s} + \frac{1-\sigma}{\sigma T_r}\right]I = a_{r11}I, A_{12} = \frac{L_m}{\sigma L_s L_r} \left[\frac{1}{T_r}I - \omega_r J\right] = a_{r12}I + a_{i12}J, A_{21} = \frac{L_m}{T_r}I = a_{r21}I,$$

$$A_{22} = \frac{-1}{T_r}I + \omega_r J = a_{r22}I + a_{i22}J$$

$$B = \left[\frac{1}{\sigma L_s}I \quad 0\right]^T, C = [I, 0], u = [V_{ds} \ V_{qs}]^T$$

(b) Adjustable Model (Luenberger Adaptive Speed Observer):

$$\frac{d\hat{x}}{dt} = [\hat{A}]\hat{x} + [B]u + [G](\hat{i}_s - i_s) \quad (13)$$

$$\hat{y} = [C]\hat{x} \quad (14)$$

Where, \hat{i}_s = estimated value of stator current and,

i_s = measured value of stator current

$$A = \begin{bmatrix} A_{11} & \hat{A}_{12} \\ A_{21} & \hat{A}_{22} \end{bmatrix}$$

$$\hat{A}_{12} = \frac{L_m}{\sigma L_s L_r} \left[\frac{1}{T_r}I - \hat{\omega}_r J\right] = a_{r12}I + \hat{a}_{i12}J, \hat{A}_{22} = \frac{-1}{T_r}I + \hat{\omega}_r J = a_{r22}I + \hat{a}_{i22}J$$

The term $[G](\hat{i}_s - i_s)$ is used as a correction term for the Adaptive Speed Observer. 'G' is the reduced order observer gain matrix designed so as to make (13) stable. The pseudo reduced order gain matrix is chosen as follows [11], [12]:

$$G = \begin{bmatrix} g_1 & g_2 \\ -g_2 & g_1 \end{bmatrix}^T \quad (15)$$

The observer gain matrix is calculated based on the pole placement technique, so that the state of the observer will converge to the reference model (the motor). Therefore, the eigen values are chosen relatively more negative than the eigen values of the reference model, so as to ensure faster convergence. It is chosen as follows:

$$g_1 = (k - 1)a_{r11}, g_2 = k_p, k_p \geq -1$$

Where, g_1 depends on the motor parameters, g_2 and k_p are arbitrarily chosen and k is an arbitrary positive constant.

(c) Adaptive Mechanism:

The Lyapunov function candidate defined for the adaptation scheme is [10]:

$$V = e^T e + \frac{(\hat{\omega}_r - \omega_r)^2}{\lambda} \quad (16)$$

Where λ is a positive constant.

The time derivative of 'V' becomes,

$$\frac{dv}{dt} = e^T [(A + GC)^T + (A + GC)] e - \frac{2\Delta\omega_r (e_{ids}\hat{\phi}_{qr}^s - e_{iqs}\hat{\phi}_{dr}^s)}{c} + \frac{2\Delta\omega_r}{\lambda} \frac{d\hat{\omega}_r}{dt} \quad (17)$$

Where,

$$e_{ids} = i_{ds} - \hat{i}_{ds} \text{ and } e_{iqs} = i_{qs} - \hat{i}_{qs}$$

By equalizing the second term with the third term, the following adaptation scheme is derived, i.e.,

$$\frac{d\hat{\omega}_r}{dt} = \frac{\lambda}{c} (e_{ids}\hat{\phi}_{qr}^s - e_{iqs}\hat{\phi}_{dr}^s) \quad (18)$$

4. SIMULATION ANALYSIS AND RESULTS

An equivalent simulation model of the above estimation schemes is built in Simulink and the performance is observed for different values of load perturbations, incorrect parameter setting and Voltage Unbalance. The Induction motor is fed from a three phase ac voltage source of rating 415V, 50Hz and is run in the motoring mode. The model is run for two sets of load torque perturbations respectively:

- Step torque – Initially at no load, after a fixed time interval, it is increased to rated load of 200 Nm.
- For a Rated Load torque of 200 Nm, the effect of change in stator resistance and rotor time constant is observed in the performance of the estimators.
- For a Rated Load torque of 200 Nm, an unbalanced three phase voltage is supplied (each phase voltage having amplitude of 200 V, 180 V and 220 V respectively).

The motor ratings and the parameters considered for simulation are given as follows: A 50HP, three-phase, 415V, 50 Hz, star connected, four-pole induction motor with equivalent parameters: $R_s = 0.087\Omega$, $R_r = 0.228\Omega$, $L_{ls} = L_{lr} = 0.8$ mH, $L_m = 34.7$ mH, Inertia, $J = 1.662$ kgm², friction factor = 0.1.

4.1. Rotor Flux based MRAS Estimator

a) Step Torque (Rated Load is applied at 5 seconds)

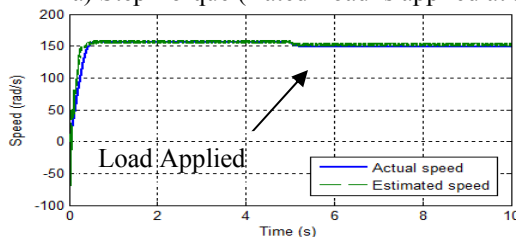

Figure 5. Speed tracking during step torque perturbation

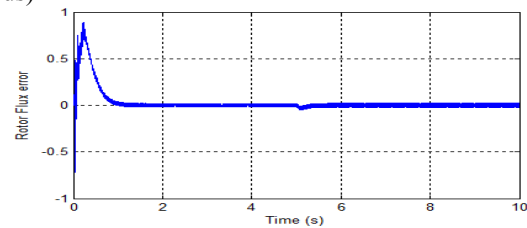

Figure 6. Rotor Flux error during step torque perturbation

b) Rated Torque (with incorrect setting of parameters)

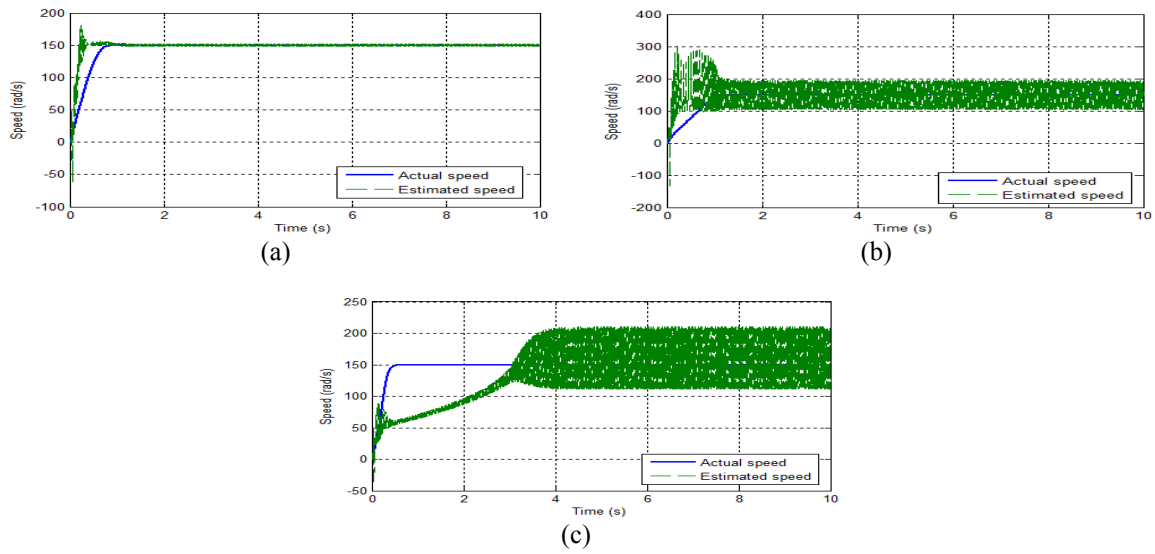

Figure 7. Speed tracking for different values of Stator Resistance (R_s) and Rotor Time constant (T_r)
 (a) R_s, T_r (b) $0.5R_s, 0.5T_r$ (c) $1.5R_s, 1.5T_r$

c) Rated Torque (with Voltage Unbalance)

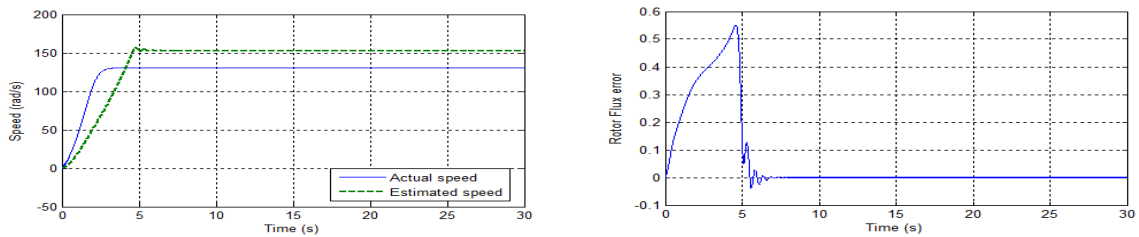

Figure 8. Speed tracking during Voltage Unbalance

Figure 9. Rotor Flux error during Voltage Unbalance

4.2. Adaptive Speed Observer

a) Step Torque (Rated Load is applied at 3.2 seconds)

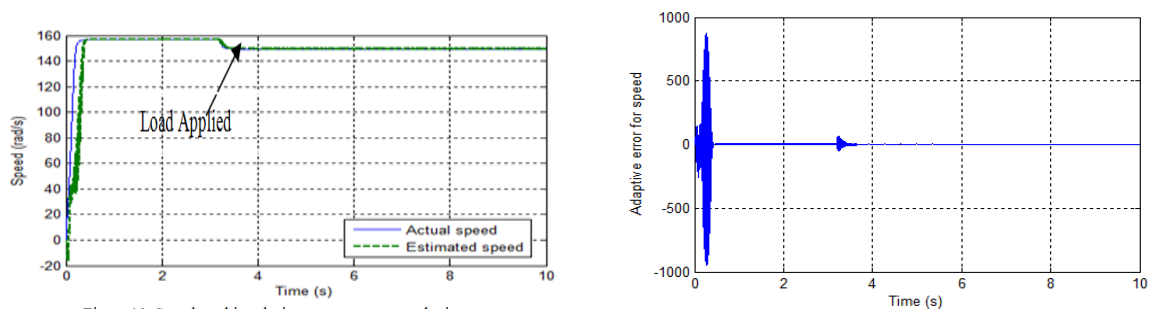

Figure 10. Speed tracking during step torque perturbation

Figure 11. Adaptive error during step torque perturbation

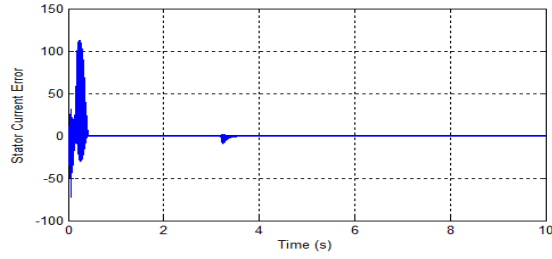

Figure 12. Stator Current error during step torque perturbation

b) Rated Torque (Incorrect setting of parameters)

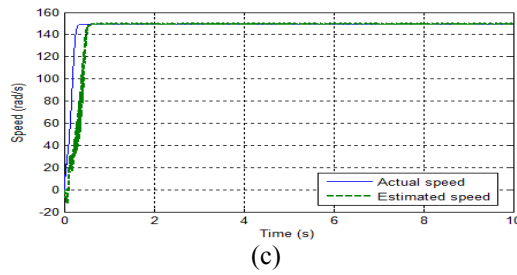
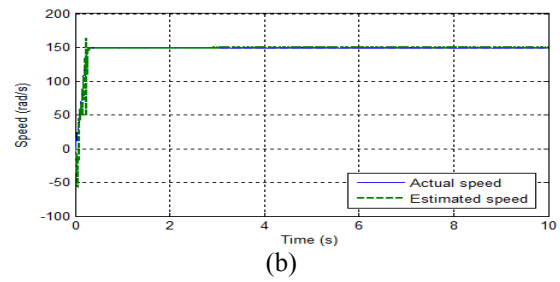
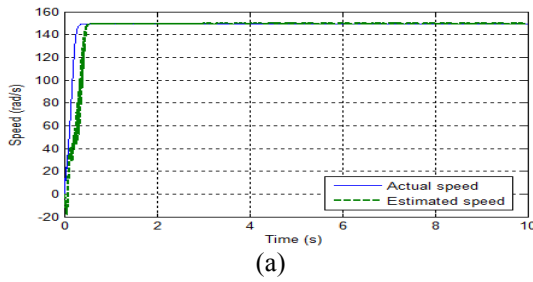

Figure 13. Speed tracking for different values of Stator Resistance (R_s) and Rotor Time constant (T_r)
 (a) R_s, T_r (b) $0.5R_s, 0.5T_r$ (c) $1.5R_s, 1.5T_r$

c) Rated Torque (with Voltage Unbalance)

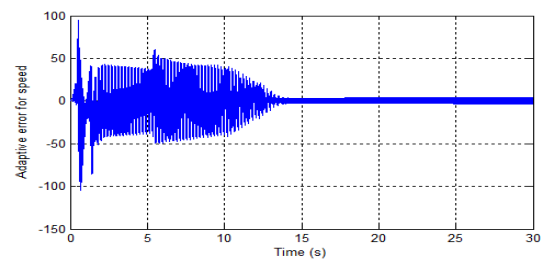
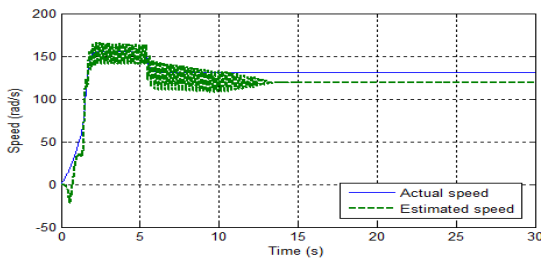

Figure 14. Speed tracking during Voltage Unbalance

Figure 15. Adaptive speed error during Voltage Unbalance

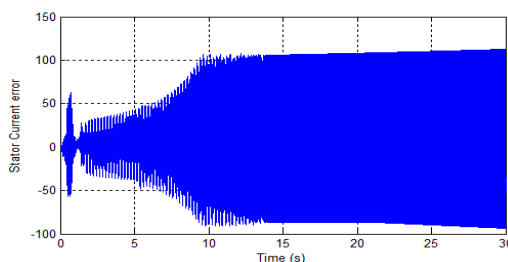

Figure 16. Stator Current error during Voltage Unbalance

The dynamic performance of the adaptive control schemes can be discussed based on the above results. In case of the Rotor Flux based MRAS Speed estimation scheme, it can be seen in Figure 5 that the estimated speed tracks the actual speed reasonably well even under step torque perturbations. The convergence of any adaption scheme is an important issue, in Figure 6 the Rotor flux error is seen to converge to zero, which is the reason the estimated speed tracks the measured speed in a very short time interval. Incorrect setting of parameters leads to high oscillations in the estimated speed which can be observed in Figure 7(b) and (c). It is also noticed that the estimated speed takes more time to track the actual speed when there is a 50% increase in the set value of the Stator resistance and Rotor time constant. During Voltage Unbalance, even though the Rotor flux error converges to zero (Figure 9), the estimated speed settles at a value of 152.9 rad/s compared to the actual speed which is about 130.2 rad/s (Figure 10). The difference in the values of the speeds can be attributed to the change in the flux level (both in the reference as well as the adjustable model) due to unbalance in supply voltage.

It can be distinctly seen that the Adaptive Speed Observer exhibits far superior tracking performance than the Rotor flux MRAS scheme. Though the tracking performance in Figure 10 is somewhat similar to that of the Rotor Flux MRAS, the difference lies when the same is subjected to parametric variations. For all the cases of Stator resistance and Rotor Time constant variations, a consistent, near smooth tracking performance is obtained which can be noticed in Figure 13(b) and (c). The adaptive error for speed derivation and the Stator current error for the observer gain converge exactly to zero, which is a primary reason for the superior tracking performance. When an unbalanced voltage is supplied, initially there are oscillations in the estimated speed, but it settles at a value (120.5 rad/s) somewhat lower than the actual speed (130.8 rad/s) which can be noticed in Figure 14. But, the differences in the speeds is relatively lesser than that of the Rotor flux MRAS scheme. This can be pertaining to the high stator current error seen in Figure 16. which affects the correction term used for the adaptive observer model.

On comparing the performance of the above speed estimation schemes, the Adaptive Speed Observer is presented as a better alternative due to its robust tracking performance and reduced oscillations. It tracks the actual speed in a relatively less amount of time. This analysis confines itself to motoring mode at speed ranges from medium to base synchronous speed.

5. CONCLUSION

This paper presented a comparison of performance of two popularly used adaptive control based speed estimation schemes, the Rotor Flux MRAS and the Adaptive Speed observer, when subjected to variations in load torque, parameters and unbalanced supply voltage. It also presented the effect of the same on the convergence mechanisms of the above adaptive schemes. The Adaptive Speed observer is found to be more efficient and robust in tracking the actual speed. Though, it is also susceptible to speed errors, the scope can be extended for joint state estimation such that, there are no mismatch in parameters during low and very low speeds.

REFERENCES

- [1] Mohammad Jannati, *et al.* Speed Sensorless Vector Control of Unbalanced Three-Phase Induction Motor with Adaptive Sliding Mode Control, *International Journal of Power Electronics and Drive System (IJPEDS)*, 2014; 4(3): 406-418.
- [2] Mohamed S Zaky, A stable adaptive flux observer for a very low speed-sensorless induction motor drives insensitive to stator resistance variations, *A in Shams Engineering Journal*, 2011; 2: 11-20.
- [3] BK Bose, *Modern Power Electronics and AC Drives*, New Delhi, India: Prentice-Hall, 2006; 8: 350-440.

- [4] Teresa Orłowska-Kowalska, Mateusz Dybkowski, Stator – Current-Based MRAS Estimator for a Wide Range Speed-Sensorless Induction-Motor Drive, *IEEE Trans. Ind. Electron.*, 2010; 57(4): 1296-1308.
- [5] Mohammad Jannati, *et al.*, Speed Sensorless Direct Rotor Field-Oriented Control of SinglePhase Induction Motor Using Extended Kalman Filter, *International Journal of Power Electronics and Drive System (IJPEDS)*, 2014; 4(4): 430-438.
- [6] H Madadi Kojabadi, *et al.* *Recent Progress in Sensorless Vector-Controlled Induction Motor Drives*, Proceedings of the Large Engineering Systems Conference on Power Engineering, IEEE 0-7803-7520-3, 2002; 80-85.
- [7] V Verma, *et al.* Performance of MRAS Based Speed Estimators for Grid Connected Doubly fed Induction Machines During Voltage Dips, *IEEE 978-1-4673-2729-9/12*, 2012; 1-8.
- [8] Ahmad Razani Haron, Nik Rumzi Nik Idris, *Simulation of MRAS-based Speed Sensorless Estimation of Induction Motor Drives using MATLAB/SIMULINK*, First International Power and Energy Conference, Putrajaya, Malaysia, 2006; 411-415.
- [9] H Kubota, K Matsuse, DSP-Based Speed Adaptive Flux Observer of Induction Motor, *IEEE Trans. Ind. Appl.*, 1993; 29(02): 344-348.
- [10] Huang Zhiwu, *et al.* *Stability Analysis and Design of Adaptive Observer Based on Speed Sensorless Induction Motor*, Proceedings of the 26th Chinese Control Conference, 2007; 28-32.
- [11] H Madadi Kojabadi, L Chang, Model Reference Adaptive System Pseudoreduced-Order Flux Observer for Very Low Speed and Zero Speed Estimation in Sensorless Induction Motor Drives, *IEEE 0-7803-7262-X/02*, 2002; 301-305.
- [12] H Madadi Kojabadi, *et al.*, Stability Conditions of Adaptive Pseudo-Reduced-Order Flux Observer for Vector-Controlled Sensorless IM Drives, *IEEE CCECE-CCGEI*, Niagara Falls, 2004; 1313-1316.

BIOGRAPHIES OF AUTHORS



Mohan Krishna.S received the B.Tech and M.Tech degrees from Amrita Vishwa Vidyapeetham, Coimbatore, India, in 2009 and 2012 respectively. Currently, he is pursuing Ph.D in Electrical engineering from VIT University, Chennai Campus, in the domain of control of induction motor drives. His research interests include sensorless speed estimation of Induction motor drives, Model Reference Adaptive Systems, Artificial Intelligence based speed estimation and other machine model based speed estimation schemes. He is a member of IAENG.



Febin Daya J. L. received his B.E. in Electrical and Electronics Engineering from Manonmaniam Sundarnar University, Tamilnadu, India, in 2002, M.E. in Applied Electronics from Anna University, Tamilnadu, India, in 2005 and PhD in Information and Communication from Anna University, Tamilnadu, India in 2013. From 2005 to 2011, he was working in the Department of Electrical and Electronics Engineering at the Sri Krishna College of Engineering and Technology, Coimbatore, India. Presently he is an Associate Professor at school of Electrical Engineering, VIT University, Chennai, India. He has published around 20 papers in International Journals and Conferences. Febin Daya is a Life Member of Indian Society of Technical Education. His current research interests include electrical drives, intelligent systems and renewable energy systems.